

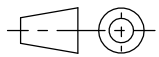



Proprieta' della D.M.B. snc- Senza autorizzazione scritta della stessa il presente disegno non potra' essere utilizzato per la costruzione dell' oggetto rappresentato ne venire comunicato a terzi.

Proiez. europ. 	Data 01-08-18	Grado di lav.	Materiale -	Tolleranze generali ±
Scala: 1:10	Dis. T.B.	 di Bailo E.& A. 38070 Stenico TN		
	Controll. P.A.			
N disegno -				
Denominazione STAND C 1450				
		Modifica	Descrizione	

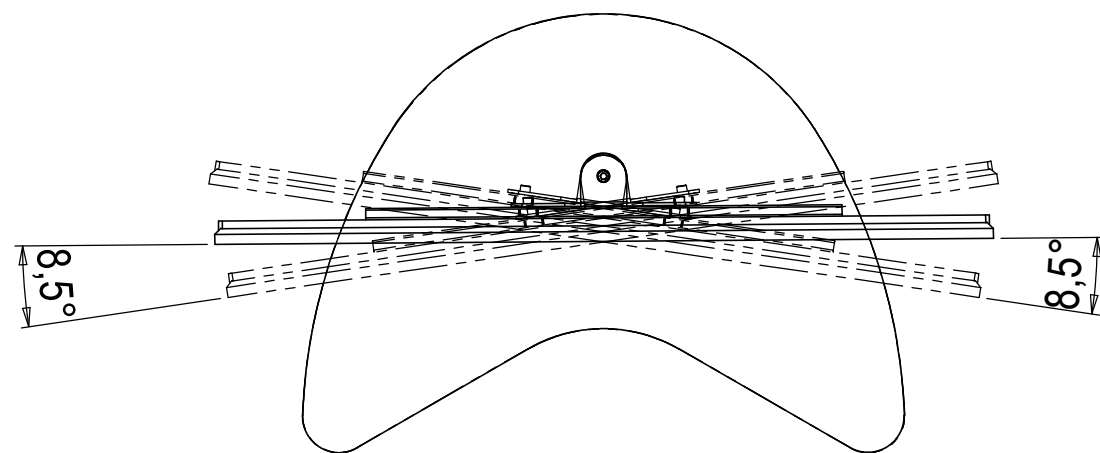
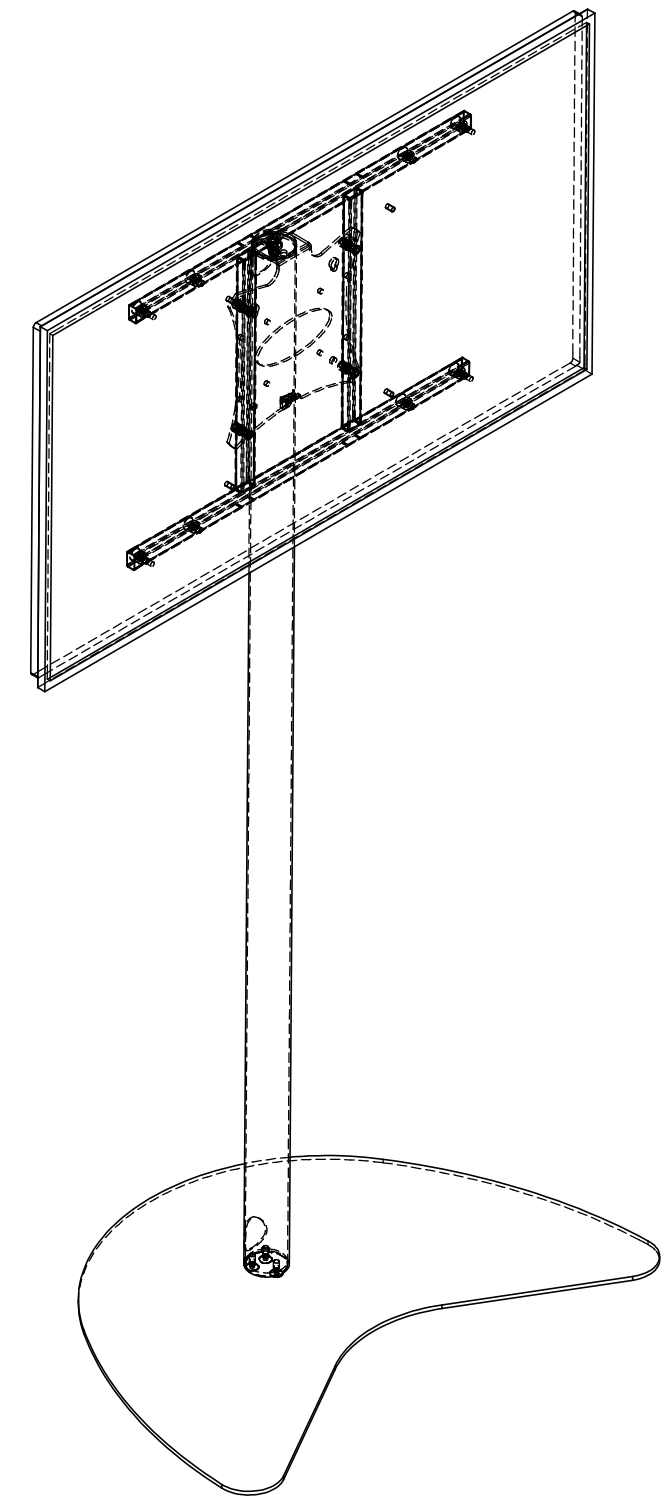
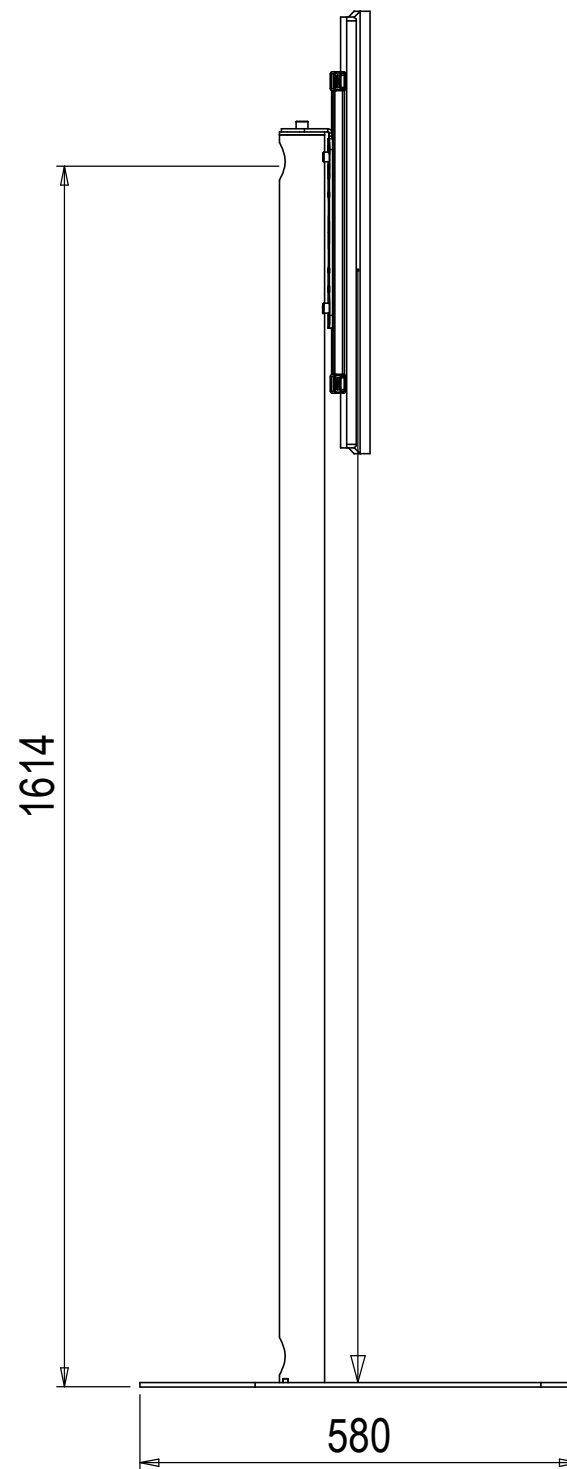
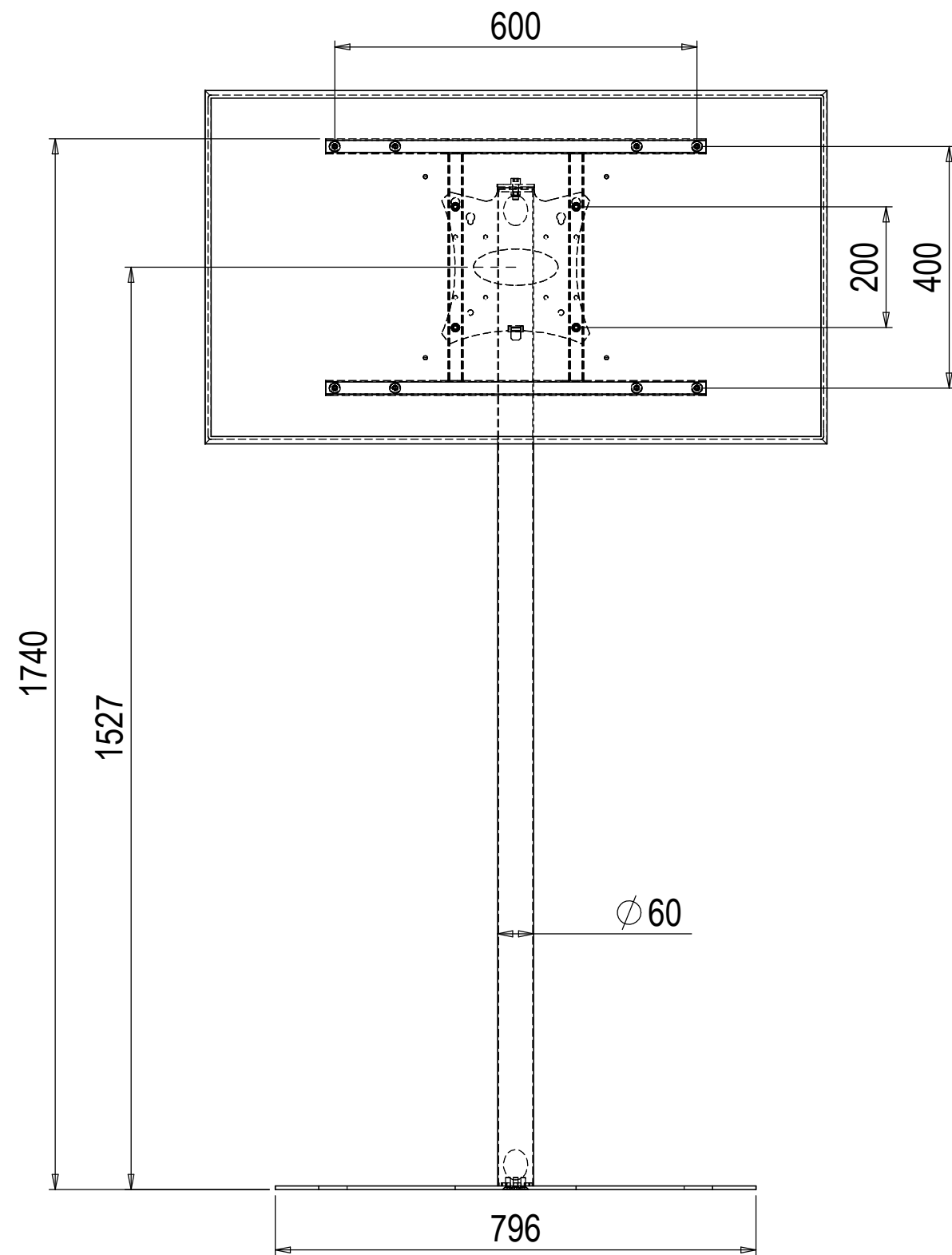

Proprietà della D.M.B. snc- Senza autorizzazione scritta della stessa il presente disegno non potrà essere utilizzato per la costruzione dell' oggetto rappresentato ne venire comunicato a terzi.

Proiez. europ. ⊕	Data 01-08-18	Grado di lav.	Materiale -	Tolleranze generali ±
Scala: 1:10	Dis. T.B.	 di Bailo E.& A. 38070 Stenico TN		
	Controll. P.A.		N disegno -	
Denominazione STAND C 1650			Modifica	Descrizione