

---

# INSTALLATION INSTRUCTIONS

---

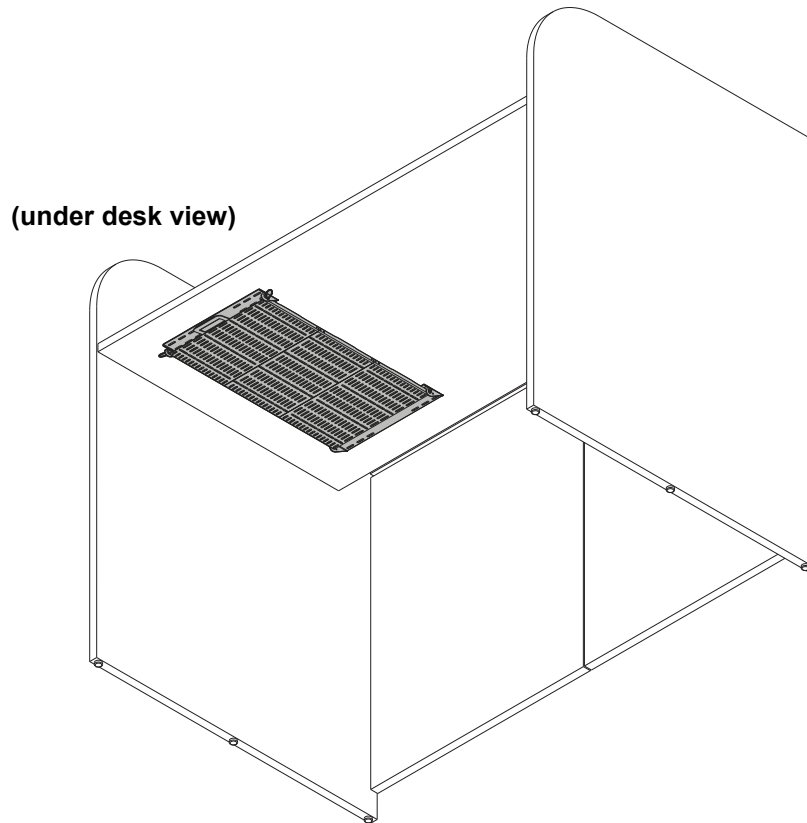

---

## Under Desk Component Storage Panel

---

---

 **CHIEF**<sup>®</sup>

A brand of  **legrand**<sup>®</sup>

**CSPH**

---

## DISCLAIMER

Legrand | AV and its affiliated corporations and subsidiaries (collectively "Legrand | AV"), intend to make this manual accurate and complete. However, Legrand | AV makes no claim that the information contained herein covers all details, conditions or variations, nor does it provide for every possible contingency in connection with the installation or use of this product. The information contained in this document is subject to change without notice or obligation of any kind. Legrand | AV makes no representation of warranty, expressed or implied, regarding the information contained herein. Legrand | AV assumes no responsibility for accuracy, completeness or sufficiency of the information contained in this document.

Chief® is a registered trademark of Legrand AV Inc.

## DEFINITIONS

**MOUNTING SYSTEM:** A MOUNTING SYSTEM is the primary Chief product to which an accessory and/or component is attached.

**ACCESSORY:** AN ACCESSORY is the secondary Chief product which is attached to a primary Chief product, and may have a component attached or setting on it.

**COMPONENT:** A COMPONENT is an audiovisual item designed to be attached or resting on an accessory or mounting system such as a video camera, CPU, screen, display, projector, etc.



**WARNING:** A WARNING alerts you to the possibility of serious injury or death if you do not follow the instructions.



**CAUTION:** A CAUTION alerts you to the possibility of damage or destruction of equipment if you do not follow the corresponding instructions.



## IMPORTANT SAFETY INSTRUCTIONS



**WARNING:** Failure to read, thoroughly understand, and follow all instructions can result in serious personal injury, damage to equipment, or voiding of factory warranty! It is the installer's responsibility to make sure all accessories are properly assembled and installed using the instructions provided.



**WARNING:** Failure to provide adequate structural strength for this accessory can result in serious personal injury or damage to equipment! It is the installer's responsibility to make sure the structure to which this accessory is attached can support five times the combined weight of all equipment. Reinforce the structure as required before installing the accessory.



**WARNING:** Exceeding the weight capacity can result in

serious personal injury or damage to equipment! It is the installer's responsibility to make sure the combined weight of all components attached to this accessory does not exceed 20 lbs (9.07 kg).



**WARNING:** Use this accessory only for its intended use as described in these instructions. Do not use attachments not recommended by the manufacturer.



**WARNING:** Never operate this accessory if it is damaged. Return the accessory to a service center for examination and repair.



**WARNING:** Do not use this accessory outdoors.







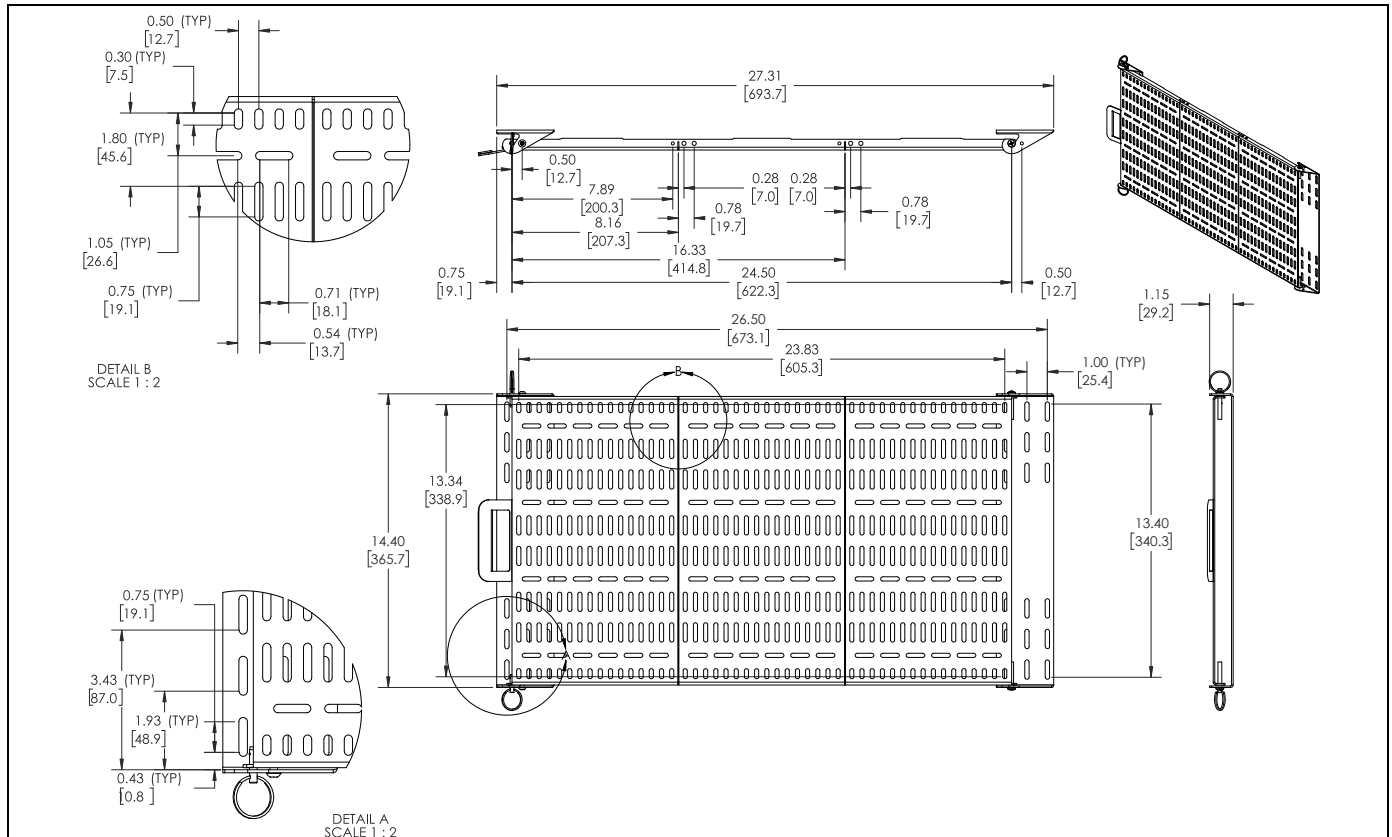

**WARNING:** RISK OF INJURY TO PERSONS! Do not use this accessory to support video equipment such as televisions or computer monitors.

**--SAVE THESE INSTRUCTIONS--**

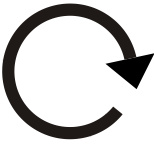
**DIMENSIONS**

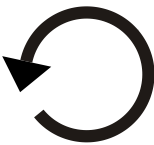

**LEGEND**

	<p><b>Tighten Fastener</b>                      Apretar elemento de fijación                      Befestigungsteil festziehen                      Apertar fixador                      Serrare il fissaggio                      Bevestiging vastdraaien                      Serrez les fixations</p>		<p><b>Pencil Mark</b>                      Marcar con lápiz                      Stiftmarkierung                      Marcar com lápis                      Segno a matita                      Potloodmerkteken                      Marquage au crayon</p>
	<p><b>Loosen Fastener</b>                      Aflojar elemento de fijación                      Befestigungsteil lösen                      Desapertar fixador                      Allentare il fissaggio                      Bevestiging losdraaien                      Desserrez les fixations</p>		<p><b>Drill Hole</b>                      Perforar                      Bohrloch                      Fazer furo                      Praticare un foro                      Gat boren                      Percez un trou</p>
	<p><b>Phillips Screwdriver</b>                      Destornillador Phillips                      Kreuzschlitzschraubendreher                      Chave de fendas Phillips                      Cacciavite a stella                      Kruiskopschroevendraaier                      Tournevis à pointe cruciforme</p>		<p><b>Security Wrench</b>                      Llave de seguridad                      Sicherheitsschlüssel                      Chave de segurança                      Chiave di sicurezza                      Veiligheidsleutel                      Clé de sécurité</p>

### TOOLS REQUIRED FOR INSTALLATION

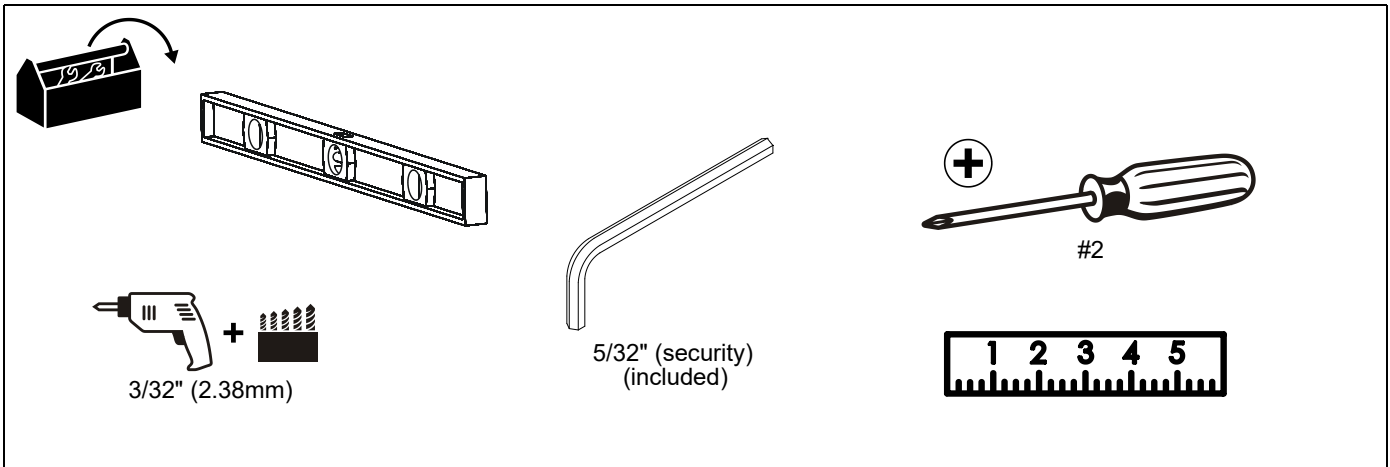

### PARTS

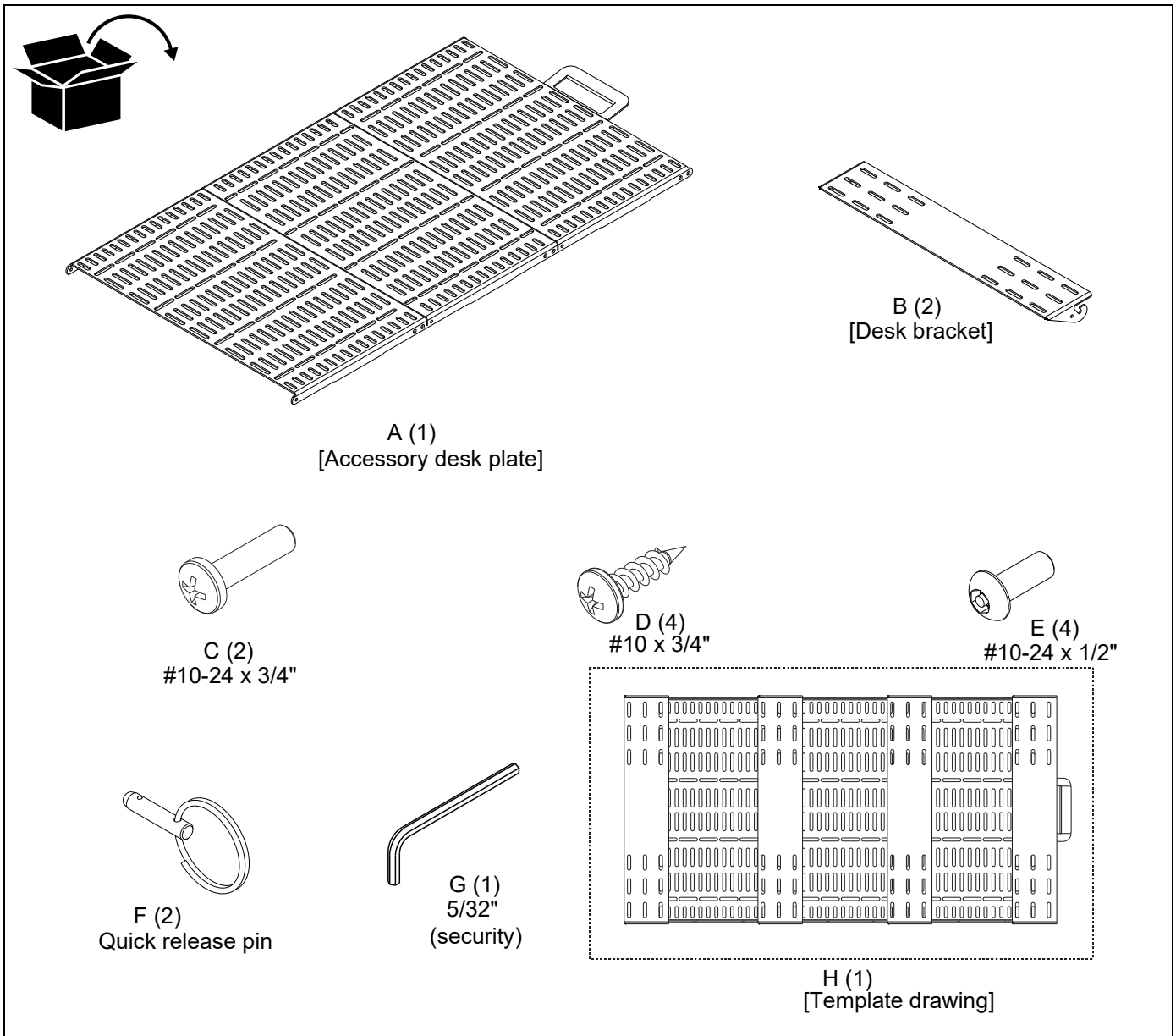

## Assembly And Installation

### CSPH Installation

1. Determine if entire accessory desk plate (A) will be used or if should be separated.
2. (Optional) Separate extra section(s) of desk plate (A) if necessary. The plate can be broken down into thirds depending on space available and user preference. (See Figure 1)

**NOTE:** Removed sections of desk plate can be used separately with a CSPHK bracket kit.

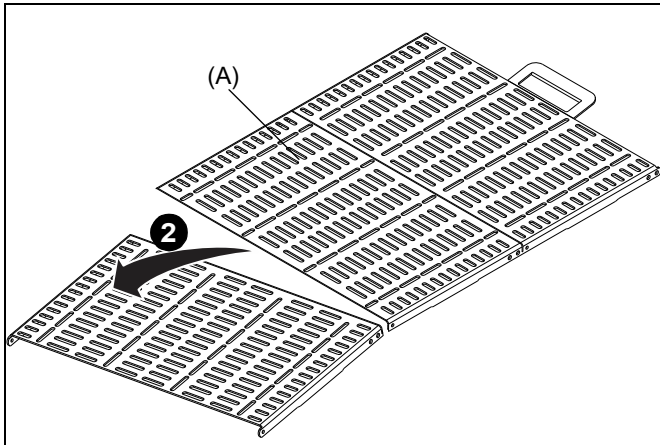
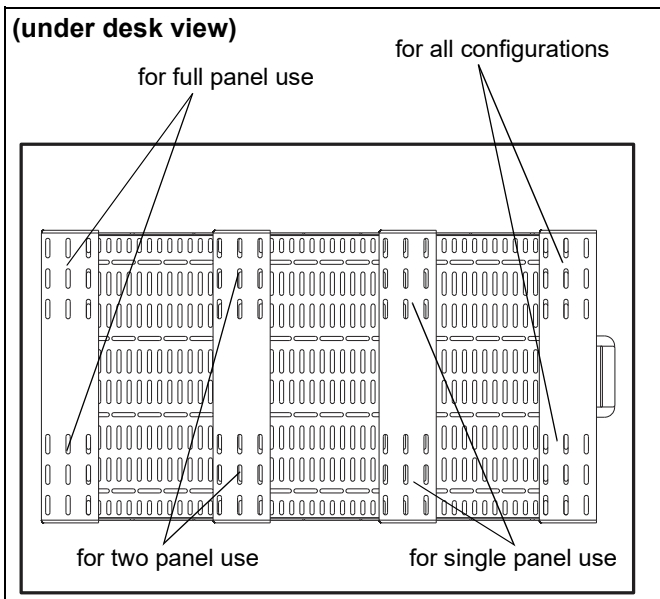

**Figure 1**

3. Use template drawing (H) to mark mounting holes on bottom of desk at desired mounting location. (See Figure 2)

**NOTE:** CSPH accessory can be installed in either direction depending on user preference

**NOTE:** Any of the nine mounting slots in each section may be used to mount plate to desk.



**Figure 2**

4. Drill four 3/32" pilot holes at marked locations under desk. (See Figure 3)

5. Use four #10 x 3/4" Phillips wood screws (D) to secure two desk brackets (B) to underside of desk. (See Figure 3)

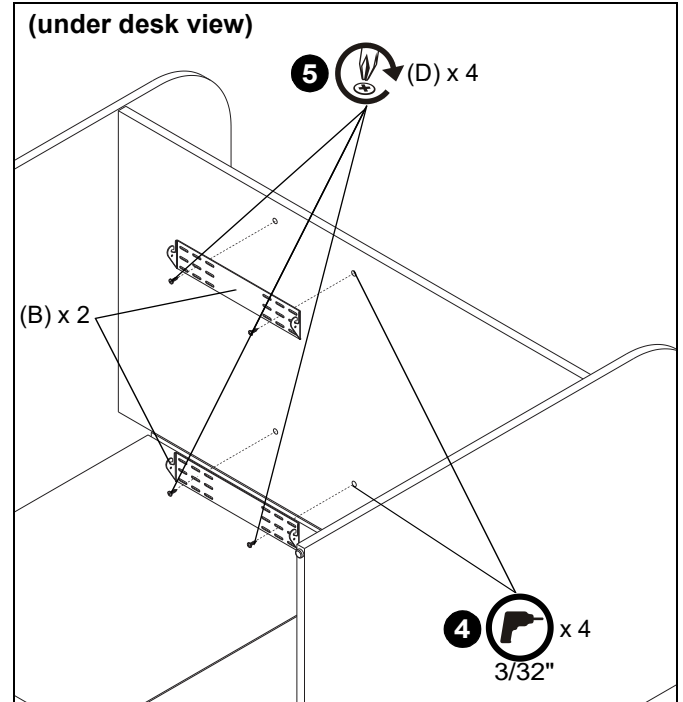

**Figure 3**

6. Loosely install two #10-24 x 3/4" Phillips pan machine screws (C) into bottom holes on accessory desk plate (A). Two #10-24 x 1/2" button head security screws (E) may be used in place of two Phillips screws (C) if greater security is desired. (See Figure 4)

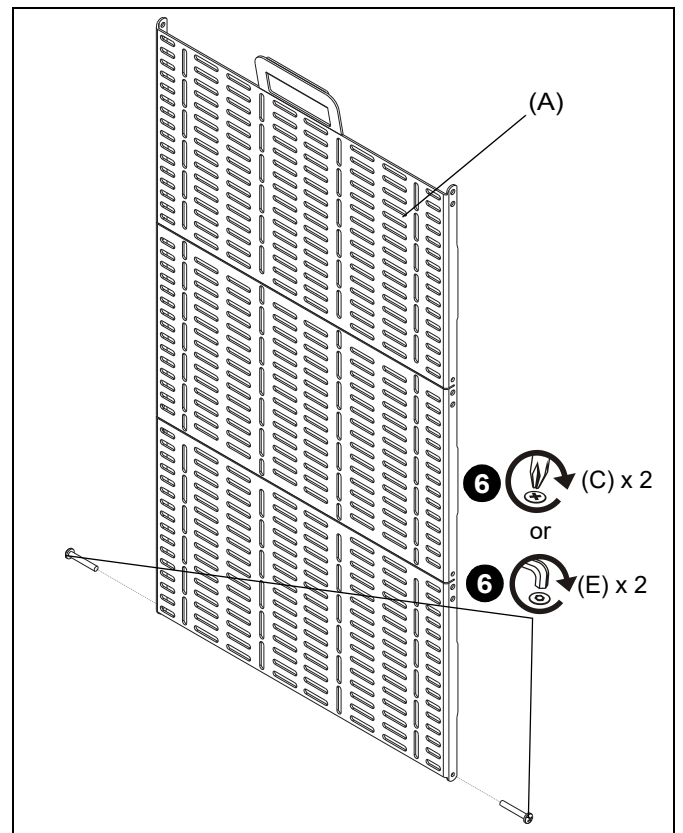

**Figure 4**

- Slide accessory desk plate (A) onto back desk bracket (B) until two screws (C) or (E) sit in slots of bracket (B). (See Figure 5)

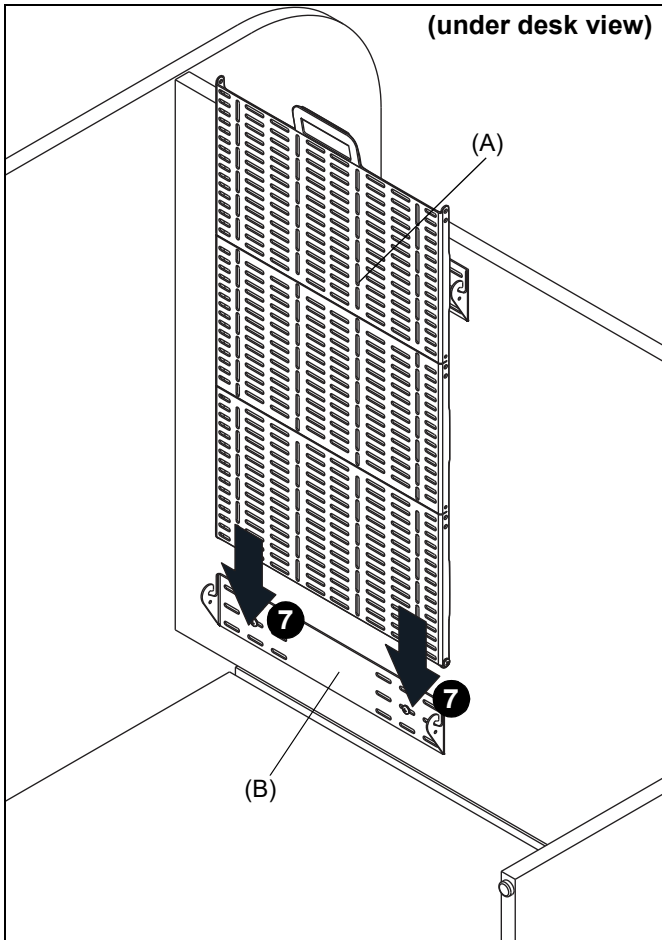

Figure 5

- Use either two quick release pins (F) or two #10-24 1/2" button head security screws (E) to secure accessory desk plate (A) to front desk bracket (B). (See Figure 6)

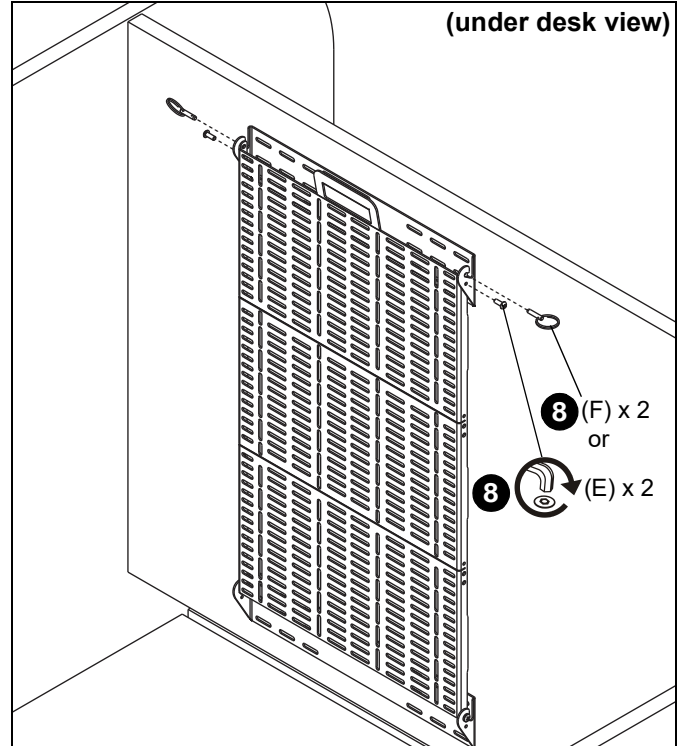

Figure 6

- Tighten all screws (C) or (E) holding accessory desk plate (A) to desk brackets (B). (See Figure 7)

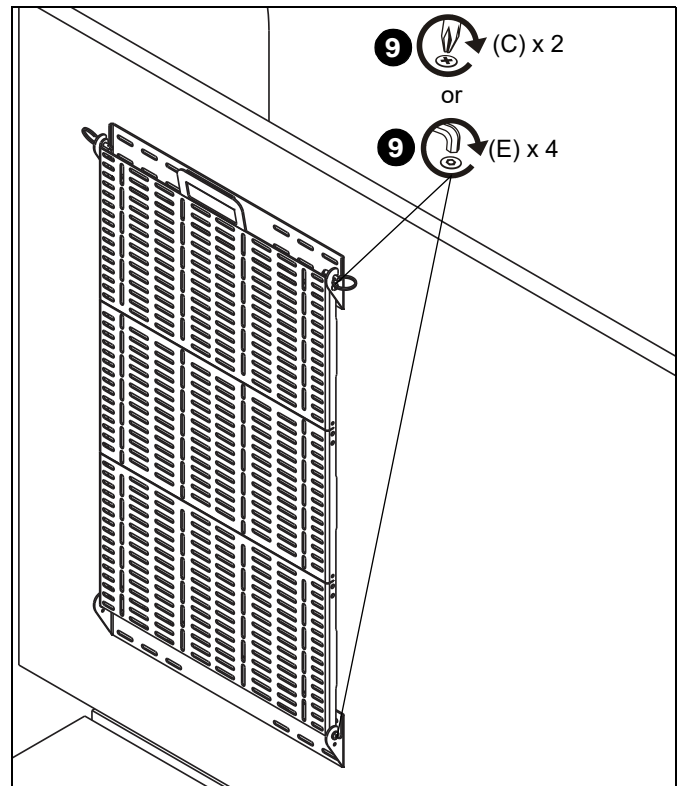

Figure 7

## Component Installation



**WARNING:** Exceeding the weight capacity can result in serious personal injury or damage to equipment! It is the installer's responsibility to make sure the combined weight of all components attached to this accessory does not exceed 20 lbs (9.07 kg).

1. Install components to accessory desk plate (A) as desired using appropriate hardware (not provided) for each component.

## Accessory Plate Removal

1. Remove security screws (E) or quick release pins (F) holding accessory desk plate (A) and to front wall bracket (B). (See Figure 8)
2. Grab handle and pull accessory desk plate (A) straight out until removed from desk brackets (B). (See Figure 8)

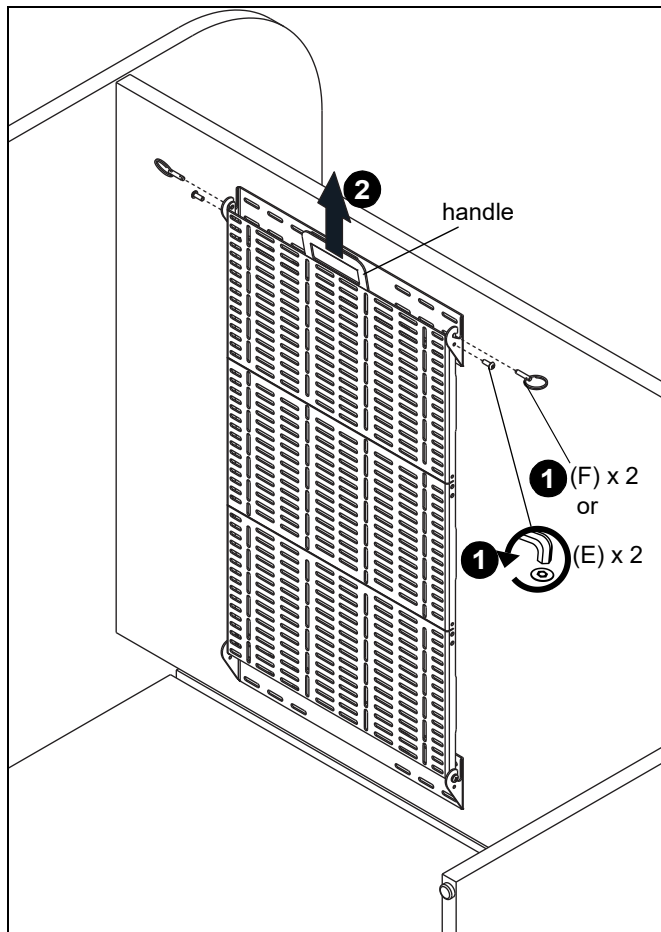

Figure 8



A brand of  **legrand**

8800-002903 Rev02  
©2019 Legrand | AV  
[www.legrandav.com](http://www.legrandav.com)  
05/19

<b>USA/International</b>	<b>A</b> 6436 City West Parkway, Eden Prairie, MN 55344 <b>P</b> 800.582.6480 / 952.225.6000 <b>F</b> 877.894.6918 / 952.894.6918
<b>Europe</b>	<b>A</b> Franklinstraat 14, 6003 DK Weert, Netherlands <b>P</b> +31 (0) 495 580 852 <b>F</b> +31 (0) 495 580 845
<b>Asia Pacific</b>	<b>A</b> Office No. 918 on 9/F, Shatin Galleria 18-24 Shan Mei Street Fotan, Shatin, Hong Kong <b>P</b> 852 2145 4099 <b>F</b> 852 2145 4477

