



SOLUZIONI PER HOTEL TV

Rel 05/10/2020





HOSPITALITY: LA NOSTRA PASSIONE

Col termine Hospitality facciamo riferimento a tutte le installazioni di tv e monitor all'interno di Hotel, ospedali, case di cura e navi da crociera, tutte situazioni "installative" che si contraddistinguono per una suddivisione molto ristretta degli spazi e l'impiego di pareti divisorie in cartongesso.



Il montaggio di televisori o impianti stereo necessita quindi di supporti specifici che permettano l'ottimizzazione di questi spazi e un buon utilizzo dei dispositivi.

Si tratta per lo più di prodotti dalle linee molto semplici che consentano una veloce installazione e manutenzione.

Ma siccome un hotel o una nave da crociera non è costituito solo da camere, il catalogo si completa di staffe e piantane per monitor di grosso formato da utilizzare con funzione informativa in reception e negli altri ambienti di intrattenimento e di quelli accessori per l'allestimento di sale riunioni di varie dimensioni.

SUPPORTI DA PARETE PER HOTEL TV



	50 x 50 75 x 75 100 x 100
	30 Kg
	10"/32"





OM07053

Installazione/Snodi:	Fisso
Distanza massima dal muro:	14 mm
Distanza minima dal muro:	14 mm
Orientamento Schermo:	L-P

OM06098



Installazione/Snodi:	1-snodo
Inclinazione Verticale:	+/-15
Rotazione:	+/-40
Portata:	10 Kg
Distanza massima dal muro:	80 mm
Distanza minima dal muro:	80 mm
Orientamento Schermo:	L-P



	50 x 50 75 x 75 100 x 100
	10 Kg
	10"/22"

SUPPORTI DA PARETE PER HOTEL TV



	50 x 50 75 x 75 100 x 100
	10 Kg
	10"/30"





OM07014

Installazione/Snodi:	2-snodi
Inclinazione Verticale:	10
Rotazione:	90
Distanza massima dal muro:	290 mm
Distanza minima dal muro:	50 mm
Orientamento Schermo:	L-P

OM07015



Installazione/Snodi:	3-snodi
Inclinazione Verticale:	10
Rotazione:	90
Distanza massima dal muro:	390 mm
Distanza minima dal muro:	50 mm
Orientamento Schermo:	L-P



	50 x 50 75 x 75 100 x 100
	10 Kg
	10"/30"

SUPPORTI DA PARETE PER HOTEL TV

VESA **200**

	50 x 50
	75 x 75
	100 x 100
	200 X 100
	30 Kg
	26"/43"





OM07054

Installazione/Snodi:	Fisso
Distanza massima dal muro:	18 mm
Distanza minima dal muro:	18 mm
Orientamento Schermo:	L-P



OM06187

Installazione/Snodi:	Fisso
Bolla di Livella:	1
Portata:	35 Kg
Distanza massima dal muro:	19 mm
Distanza minima dal muro:	19 mm
Dimensione supportate monitor:	10-40
Orientamento Schermo:	L-P



	50 x 50
	75 x 75
	100 x 100
	35 Kg
	10"/40"

SUPPORTI DA PARETE PER HOTEL TV

  	75 x 75 100 x 100 200 X 100 200 X 200
	30 Kg
	19"/32"



ER044020



Installazione/Snodi:	Fisso
Bolla di Livella:	1
Distanza massima dal muro:	48 mm
Distanza minima dal muro:	16 mm
Orientamento Schermo:	L-P

OM06120



Tasca con forature vesa standard da montare tra la staffa e il tv per alloggiare decoder e piccoli lettori DVD

Dimensioni	530x300x400 Mm
Installazione/Snodi:	Fisso
Distanza massima dal muro:	60 mm
Distanza minima dal muro:	60 mm
Orientamento Schermo:	L



  	75 x 75 100 x 100 200 x 100 200 x 200
	30 Kg
	15"/40"

SUPPORTI DA PARETE PER HOTEL TV

	50 x 50 75 x 75 100 x 100 200 X 100 200 X 200
	20 Kg
	10"/32"





OM36070

Installazione/Snodi:	1-snodo
Inclinazione Verticale:	20
Rotazione:	90
Distanza massima dal muro:	90 mm
Distanza minima dal muro:	90 mm
Orientamento Schermo:	L

OM06174



Installazione/Snodi:	2-snodi
Inclinazione Verticale:	20
Rotazione:	180
Distanza massima dal muro:	288 mm
Distanza minima dal muro:	50 mm
Orientamento Schermo:	L-P



	100 x 100 200 x 100 200 x 200
	25 Kg
	10"/40"

SUPPORTI DA PARETE PER HOTEL TV

VESA **200**

  	50 x 50
	75 x 75
	100 x 100
	200 X 100
	200 X 200
25 Kg	
10"/40"	





OM6176

Installazione/Snodi:	3-snodi
Inclinazione Verticale:	20
Rotazione:	180
Distanza massima dal muro:	376 mm
Distanza minima dal muro:	50 mm
Orientamento Schermo:	L-P



ER048120

Installazione/Snodi:	2-snodi
Inclinazione Verticale:	15
Rotazione:	60
Distanza massima dal muro:	122 mm
Distanza minima dal muro:	47 mm
Orientamento Schermo:	L-P



  	200 x 200
	15 Kg
	15"/37"

SUPPORTI DA PARETE PER HOTEL TV

	50 x 50
	75 x 75
	100 x 100
	200 X 100
	15 Kg
	15"/37"
	





ER048220

Installazione/Snodi:	2-snodi
Inclinazione Verticale:	15
Rotazione:	180
Distanza massima dal muro:	240 mm
Distanza minima dal muro:	47 mm
Orientamento Schermo:	L-P

ER048320



Installazione/Snodi:	3-snodi
Inclinazione Verticale:	15
Rotazione:	180
Distanza massima dal muro:	410 mm
Distanza minima dal muro:	47 mm
Orientamento Schermo:	L-P
Compatibilità:	Vesa: 50x50, 100x100,



	50 x 50
	75 x 75
	100 x 100
	200 X 100
	15 Kg
	15"/37"
	

SUPPORTI DA PARETE PER HOTEL TV

VESA **400**

	da 200 x 200 a 400 x 400
	35 Kg
	26"/55"





OM07055

Installazione/Snodi:	Fisso
Distanza massima dal muro:	25 mm
Distanza minima dal muro:	25 mm
Orientamento Schermo:	L-P

OM07056

Installazione/Snodi:	Inclinabile
Inclinazione Verticale:	12
Distanza massima dal muro:	25 mm
Distanza minima dal muro:	25 mm
Orientamento Schermo:	L-P



	da 200 x 200 a 400 x 400
	35 Kg
	26"/55"

SUPPORTI DA PARETE PER HOTEL TV

VESA **400**



da 200 x 200
a 400 x 400



50 Kg



32"/55"



OM06170

Installazione/Snodi:	Fisso
Distanza massima dal muro:	22 mm
Distanza minima dal muro:	22 mm
Orientamento Schermo:	L

ER044040

Installazione/Snodi:	Fisso
Bolla di Livella:	1
Distanza massima dal muro:	48 mm
Distanza minima dal muro:	16 mm
Orientamento Schermo:	L-P



da 200 x 100
a 400 x 400





50 Kg



37"/65"

SUPPORTI DA PARETE PER HOTEL TV

VESA **400**

  	100 x 100
	200 x 100
	200 x 200
	300 x 300
	400 x 200
400 x 400	
25 Kg	
26"/55"	

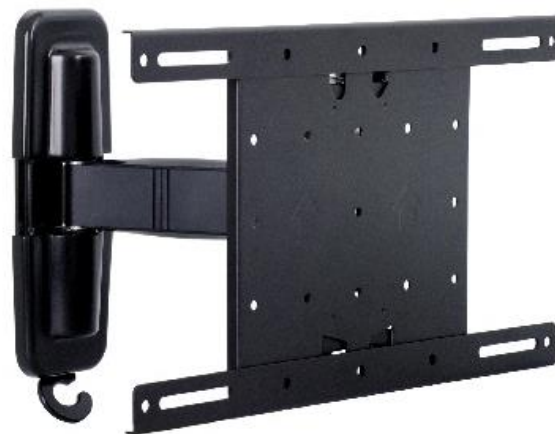



MB4210

Installazione/Snodi:	2-snodi
Inclinazione Verticale:	15
Rotazione:	90
Distanza massima dal muro:	225 mm
Distanza minima dal muro:	37 mm
Orientamento Schermo:	L-P

RO17.99.1144



Installazione/Snodi:	3-snodi
Inclinazione Verticale:	+5 -15
Rotazione:	+/- 90
Distanza massima dal muro:	615 mm
Distanza minima dal muro:	49 mm



  	200 x 200
	300 x 300
	400 x 400
35 Kg	

SUPPORTI DA PARETE PER HOTEL TV

VESA **400**

 VESA	200 x 200 400 x 400
 KG	25 Kg
	30"/65"





ER048140

Installazione/Snodi:	2-snodi
Inclinazione Verticale:	25
Rotazione:	55
Distanza massima dal muro:	125 mm
Distanza minima dal muro:	46 mm
Orientamento Schermo:	L-P

ER048240



Installazione/Snodi:	2-snodi
Inclinazione Verticale:	25
Rotazione:	180
Distanza massima dal muro:	325 mm
Distanza minima dal muro:	49 mm



 VESA	200 x 200 400 x 400
 KG	25 Kg
	30"/65"

SUPPORTI DA PARETE PER HOTEL TV

VESA **400**

 VESA	200 x 200 400 x 400
 KG	25 Kg
	30"/55"





ER048340

Installazione/Snodi:	3-snodi
Inclinazione Verticale:	25
Rotazione:	180
Distanza massima dal muro:	538 mm
Distanza minima dal muro:	49 mm
Orientamento Schermo:	L-P



OM06144

Installazione/Snodi:	Fisso
Distanza massima dal muro:	22 mm
Distanza minima dal muro:	22 mm
Orientamento Schermo:	L



 VESA	da 200 x 200 A 600 x 400
 KG	50 Kg
	37"/65"

SUPPORTI DA PARETE PER HOTEL TV

	da 200 x 100 a 600 x 400
	70 Kg
	42"/75"





ER044060

Installazione/Snodi:	Fisso
Bolla di Livella:	1
Distanza massima dal muro:	48 mm
Distanza minima dal muro:	16 mm
Orientamento Schermo:	L



MB4166

Installazione/Snodi:	Fisso
Bolla di Livella:	1
Distanza massima dal muro:	20 mm
Distanza minima dal muro:	20 mm
Orientamento Schermo:	L



	da 200 x 200 a 600 x 400
	80 Kg
	65"/75" P 40"/75" L

SUPPORTI DA PARETE PER HOTEL TV

	da 100 x 100 a 600 x 400
	70 Kg
	42"/75"





RO17.99.1205

Installazione/Snodi:	multisnodo
Inclinazione Verticale:	15
Rotazione:	120
Distanza massima dal muro:	510 mm
Distanza minima dal muro:	64 mm
Orientamento Schermo:	L



ER48590

Installazione/Snodi:	multisnodo
Inclinazione Verticale:	15
Rotazione:	160
Distanza massima dal muro:	538 mm
Distanza minima dal muro:	68 mm
Orientamento Schermo:	L



	da 200 x 100 A 600 x 400
	70 Kg
	33"/85"

ADATTATORI VESA

 VESA	75 x 75
 KG	kg
	



RO17.99.1110

Piastra adattatore per trasformare le staffe vesa 75 x 75 in vesa 100 x 100 e 200x100.



Colore Silver

RO17.03.1106



Adattatore per trasformare VESA 100, VESA 200 (100 x 200 & 200 x 200 mm) in VESA 100 (100 x 100 mm).

Colore Silver



 VESA	100 x 100 100 x 200 200 x 200
 KG	kg
	

ADATTATORI VESA

 VESA	100 x 100
 KG	30 Kg
	

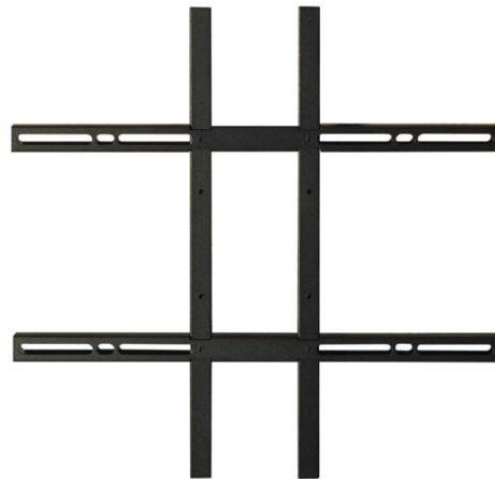

OM36088

Adattatore per convertire VESA 100 x 100 fino a VESA 400x400



SUPPORTI MOTORIZZATI PER HOTEL TV



VESA

100 x 100
200 x 100
200 x 200
400 x 200
300 x 300
400 x 400



KG

30 Kg



32"/55"



MB1028

Inclinazione Verticale: 75

Orientamento Schermo: L

USE YOUR OWN REMOTE

MB4500

Installazione/Snodi: 2-snodi

Rotazione: 180

Orientamento Schermo: L

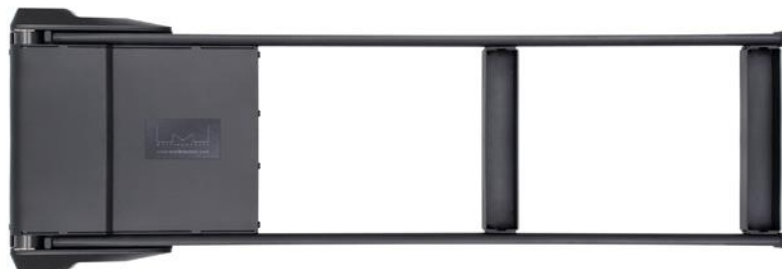

VESA

200 x 200
300 x 200
400 x 200
400 x 400
600 x 400





KG

30 Kg



32"/60"

SUPPORTI DA TAVOLO PER HOTEL TV

 VESA	da 200 x 200 a 800 x 400
 KG	30 Kg
	40"/55"



PE1475PR

Installazione/Snodi:

Fisso

Orientamento Schermo:

L-P

MB3323

Installazione/Snodi:

1-snodo

Inclinazione Verticale:

45



Rotazione:

90



Orientamento Schermo:

L-PL



 VESA	75 x 75 100 x 100
 KG	10 Kg
	15"/27"

SUPPORTI DA TAVOLO PER HOTEL TV

	200 x 200
	300 x 300
	400 x 200
	400 x 400
	30 Kg
	24"/43"
	



MB1114

Installazione/Snodi:

1-snodo

Orientamento Schermo:

L

MB1121



Installazione/Snodi:

1-snodo

Orientamento Schermo:

L



	200 x 200
	300 x 300
	400 x 200
	400 x 400
	40 Kg
	32"/60"
	

CARRELLO MECCANICO CON REGOLAZIONE DELL'ALTEZZA – 90 kg - 55" - 80"



MB4627

Carrello per videoconferenza con ripiano e supporto webcam inclusi, dotato di 4 ruote di cui 2 con freno integrato.

H max c/s 165 cm.

Colore Nero

Portata max: 90 Kg

Vesa: 200x200, 300x200, 300x300,
400x200, 400x400, 600x400, 800x400,
800x500mm

Dimensioni consigliate del monitor
55" - 80"

Garanzia 5 anni.

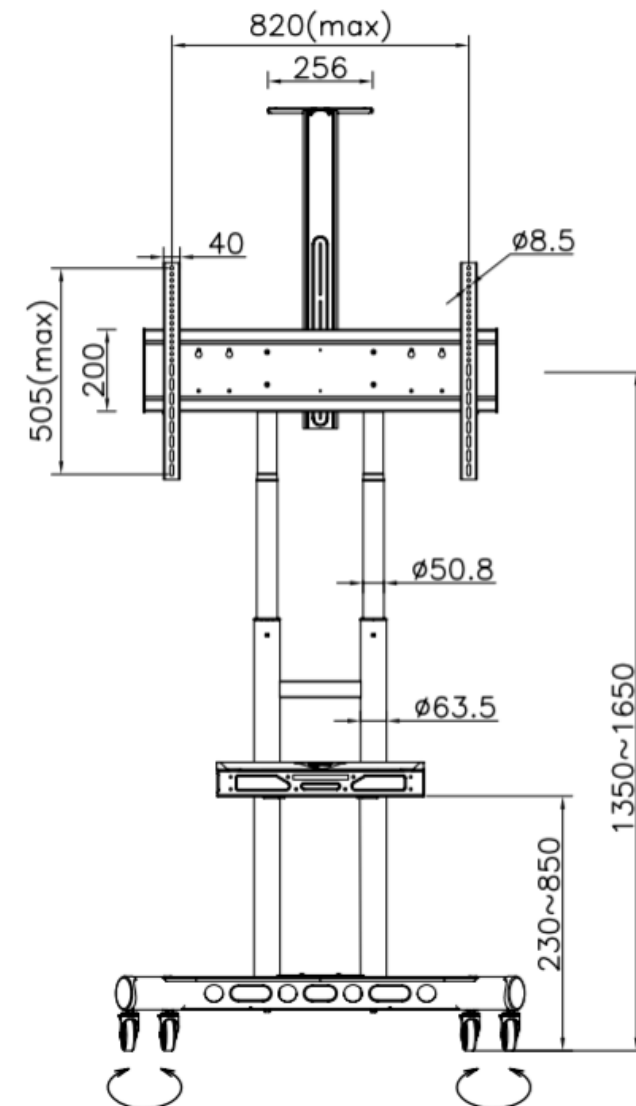

CARRELLO MECCANICO CON REGOLAZIONE DELL'ALTEZZA – 100 kg - 60'' - 100''



RO17.03.1261

Carrello per videoconferenza con ripiano e supporto webcam inclusi, dotato di 4 ruote di cui 2 con freno integrato. Regolabile in altezza, tilt $+5^\circ$ / -10° . H c/s 120/165 cm.

Color alluminio/Nero

Portata max: 100 Kg

Vesa: da 200x200 a 1000x600 mm

Dimensioni consigliate del monitor 60''-100''

Garanzia 1 anno.

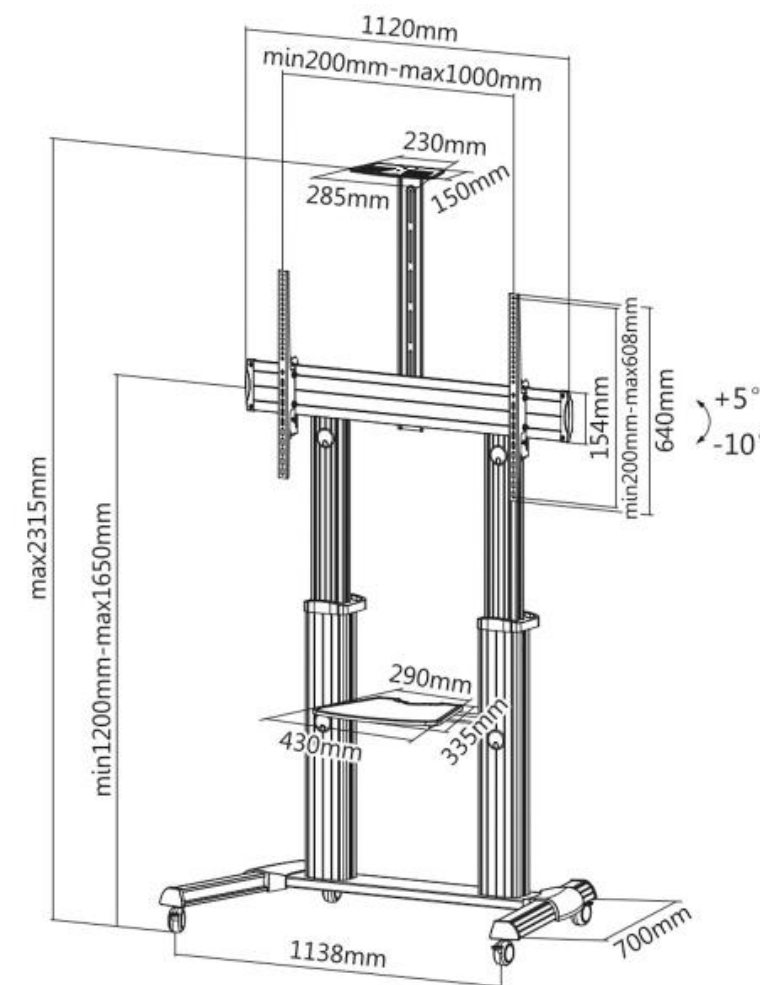

SUPPORTO MOTORIZZATO PER SCHERMO PIATTO REGOLABILE IN ALTEZZA, DI GRANDE CAPACITA'

90 kg - 40'' - 98''



Ideali per applicazioni interattive, i supporti con capacità di regolazione elettrica dell'altezza creano una migliore accessibilità alla tecnologia nella sala. Facile da installare. Facile da regolare.

Funzionalità chiave

Il sensore anticollisione si arresta immediatamente, quindi inverte il movimento del display quando incontra un ostacolo per evitare di pizzicare le dita o danneggiare la tecnologia

Range di regolazione verticale:	650 mm
Distanza da terra a centro monitor:	da 1069.09 a 1719.07mm
Certificazioni:	UL Listed, TÜV Certified
Colore:	Nero
Compatibilità della staffa di montaggio:	Universale da 200x200 a 860x510mm
Presa di corrente:	CEE7-XVII
Tilt:	0, 2, 4 gradi di incremento
Capacità di carico:	90 kg

CHLPE1U-EU





LUIGI VILLA

Managing Director

+39 02 48777523

luigi.villa@itbsolution.it

RAFFAELLA MATTI

Key Account

+39 02 48777522

raffaella.matti@itbsolution.it

FEDERICA VILLA

Key Account

+39 02 48777525

federica.villa@itbsolution.it

ALICE COSSETTINI

Customer Service

+39 02 48777527

alice.cossettini@itbsolution.it

FABIO FRACCASTORO

Key Account

+39 02 48777521

fabio.fraccastoro@itbsolution.it

PAOLO FEDE

Purchasing

+39 02 48777520

acquisti@itbsolution.it

La nostra missione

Come tutti i progetti, anche ITB ha un obiettivo ben definito in mente: fornire ai clienti – siano essi di piccole dimensioni o colossi del settore – assistenza e competenza per la fornitura di marchi universalmente riconosciuti come affidabili e di qualità.

E come lo vuole raggiungere? Con il duro lavoro, con la predisposizione ad ascoltare per apprendere e per aiutare. Con la sua natura ibrida di brand e distributore: il fatto di non essere un'azienda rigidamente strutturata fa in modo che si possa venire incontro ad una serie di esigenze non convenzionali, che si abbiano orizzonti più ampi, che si disponga di una certa flessibilità di pensiero e che si disponga di una ottima capacità di problem solving nel caso di situazioni senza precedenti.

Così, proprio dove potrebbe sussistere un problema, ITB lo trasforma in valore aggiunto.



ITB S.r.l.

Via Rembrandt, 2

20148 – Milano (MI)

C.F. / Partita IVA: 12047830158

Magazzino:

c/o OMB Via Nazionale, 15

Campo Lomaso

38077 Comano Terme

Tel. +39 02 4877751

info@itbsolution.it